



Manufacturers of Professional Floor Covering Tools & Equipment



Floor Prep



Carpet Installation Tools



Moisture/pH Testing



Linoleum/Vinyl Tools

Laminate Installation Tools



Material Handling Equipment

www.taylortools.com



This catalog provides a wealth of information on the many quality products manufactured by Taylor Tools that have been specifically developed for floor preparation and installation professionals.

As complete as it is, however, much of the information contained herein is subject to change as the Taylor Tools product line continually evolves - new products are added, existing products are improved, additional services are offered...

That's why we strongly encourage you to supplement the information contained in this catalog with the latest information and additional resources you'll find on our newly re-designed website at TaylorTools.com

The Taylor Tools website is chockful of useful stuff for flooring professionals including:

[Updated Product Information.](#)

As we continue to develop innovative tools or make improvements and enhancements to our current products, the latest information can always be found at TaylorTools.com.

[Moisture Testing Tools](#)

- An easy-to-use online calculator for quick Calcium Chloride moisture test results
- A printable log sheet for in-situ moisture meter results
- A printable log sheet for Calcium Chloride test results

[Taylor Tools Newsletter](#)

A sign-up form adds you to our email list for the latest product and pricing information from Taylor Tools.

[Taylor Products In Action!](#)

Several instructional and product demonstration videos highlight the many features and advantages of the Taylor Tools professional product lineup.

[Authorized Distributors](#)

A current list of all Taylor Tools distributors with contact information and website links. The list includes international distributors.

[Replacement Parts](#)

Here you'll find detailed drawings of many of our products and a complete parts list to make it easy to order replacement parts.

[Monthly Tool Specials!](#)

A list of our Tools of the Month describing how you can save by buying selected products during the month they're featured.

Table of Contents



Floor Preparation	Page	Carpet Installation Tools	Page	Carpet Binding	
Blade Packages	5	Brooms, Floor	41	Instabind	41
Carpet Tearor	10	Brush, Counter	41		
Clamps, Carpet	9	Carpet Guards	30	Restoration Tools	
Diamabrush	11	Cutter, Cushion Back	35	Ceramic Doctor	42
Durablades	7-8	Door Hinge Pin Removers	37	Wood Doctor	42
Extreme Machine & Attachments	12-13	Drive Down Bar	39		
Sand Paper-Extreme Machine	14	E-Z Tuck, Deluxe E-Z Tuck	36	Laminate/Vinyl Installation Tools	
EZ Scrape	13	Glue Gun and Tips	40	Fast Strap	43
Lockjaws	9	Glue Sticks	40	Laminate Installation Kit	43
Pogo Scraper	16	Heat Gun	39	Parquet Spacer	43
Scraper, Spud Bar	16	Kicker Pick/Row Tracker	27	Pico Groover	44
Solvent Cleaners	15	Knee Kicker, Deluxe	30	Power Shunting Device	43
Spud Bar, Contractor Grade	16	Knee Kicker, Deluxe	30	Provinol Seam Cutter	44
Stripper, Bronco	1-2	Linoleum Rollers	38	Vacuum Cup	43
Stripper, Heavy Duty (#462, #463)	5	Loop Pile Cutter	35	Vinyl Tile Cutter	44
Stripper, Samurai	6	Molding Lifter	38		
Stripper, Self-Propelled (#464)	4	Nail Driver, Concrete	37		
Stripper, Variable Drive (465VDC)	3	Restretcher, Mini	25		
Stripper Machine Specifications	6	Seam Rollers	32		
Vacuums	17-18	Seam Weld Iron, Tru-Trak	31		
		Seaming Iron, Conventional	32		
		Seaming Irons, Taylor	29		
Material Handling Equipment		Seaming Iron Replacement Parts	33-34		
Carpet Cart	20	Sharkteeth	26		
The Mule	20	Shears	41		
No-Flat Tire	20	Stair Tool	36		
Sta-Tite Belt Tightener	19	Stapler, Triple Threat	28		
Uni-Lift	19	Straight Edge, Aluminum	38		
		Stretchers, Power	25		
Moisture Testing		Stretcher Adapter Tubes	25		
Delmhorst Moisture Meters	21-22	Stretcher Hook	27		
Mini-Precision Balance	24	Tool Box	40		
Moisture Test Kits	23	Tool Kit, Carpet Installation	40		
Moisture Test Kit Gram Scale	23	Tool Pouch, Leather	39		
pH meter	23	Trimmer, Conventional	35		
Pocket Calculator	24	Trimmer, Cushion Back Wall	35		
Superdome DIY System	24	Trimmer, Multi-Purpose Wall	28		

Floor Preparation

For the most demanding floor removal jobs - everything from direct glue down carpet and resilient installations to ceramic and hardwood - Taylor Tools offers the most complete line of floor removal equipment and tools in the industry.



Speed Does Matter!

At 300 to 400 surface feet/minute, Broncos have more than twice the removal rate of competitive machines.

The patented (pat#6273513) and patent pending Bronco is a major breakthrough in floor removal equipment design.

For the first time, removal rates are not dependent on a machine's sheer size and weight. The Bronco equals or outperforms those large, heavy, expensive, awkward machines but comes in a small, compact size.

And the Bronco is available with three different power options: The super-clean electric model, the low-emission, propane-powered version or the new battery-operated Hybrid Bronco. Whichever Bronco you choose, you'll get the same great features including high performance with low maintenance.

Small, but powerful, the Bronco is easy to transport in a standard garden trailer or pick-up truck rated 3/4 ton or heavier, when loaded and unloaded with a forklift. Only 29" wide, the Broncos fit in passenger elevators and through doorways making it ideal for residential applications.

The adjustable Power-Glide™ articulating suspension system keeps the blade engaged at all times.

The unique, articulating Power Wedge™ design reaches into tight corners and provides as much power as heavier, more expensive machines. Easy-to-operate controls allow for a zero turn radius.

The Bronco has only five drive components - a motor, two pumps and two gear motors. That's why we can go the extra mile and extend every Bronco a limited 1 year warranty. And you can lease a Bronco for as little as \$600 per month.

So, before you invest in a professional grade stripper, you owe it to yourself and the success of your company to check out the revolutionary Bronco.

Removal rates, blade life and equipment maintenance vary depending on the installation materials and techniques originally used to install the floor covering.

The line includes hand scrapers, buffers, walk-behind strippers and, for large commercial removal jobs, you can't beat one of our compact, but powerful, Broncos.

Articulating Suspension



Pat. # 6273513 & Patent pending.

Hybrid #260B

Up To Twice The Removal Rate of Other Battery Machines!

- Up to 15,000 sq. ft. per charge. Battery Operated . . . 110V Cord-Powered . . . or both . . . It's your choice!
- Cord-Power plus a Fully-Charged Battery doubles the operating time!
- Fast, convenient, On-Board Charging System charges each battery equally. This technology greatly extends the battery pack life!



Battery Monitor Can More Than Double Your Battery Pack Life!

A new battery monitor on the Bronco Hybrid can identify the actual voltage of each of the 16 batteries to identify exactly which battery may not be charging properly and need replacement.

When a single battery in a battery pack does not fully charge with the rest of the batteries, it will not only reduce run times but dramatically reduce the life of the entire battery pack.

A simple replacement of the deficient battery will keep the battery pack at optimum performance and extend the life of the battery pack by more than double.



See the Hybrid Bronco in action at taylortools.com/videos.html

All specifications are approximate

Hydraulic Blade Control NEW for 2009



Articulating Suspension

Pat. # 6273513 & Patent pending.



See the 260P-HL in action at taylortools.com/videos.html

Propane-Powered #260P-HL

- Powerful, low-emission, high-performance, low-maintenance 17HP Kawasaki engine
- Strip up to 15,000 sq. ft. per day



A unique hydraulic lift provides faster, easier blade changing, infinitely variable blade angle adjustment and simplified transportation. Patent pending.

Corded Electric Powered #260

- 200' cord included.
- Quiet, super-clean, 7 1/2HP, 220V, single phase electric motor.
- No emissions to monitor or ventilate

For removing:

- Adhesive applied carpeting
- Resilient sheet goods
- Rubber and vinyl tile
- Plastic
- Rubber
- Ice
- Epoxy Resins
- Ceramic-Broncos & Pogo Scraper (see pg. 14) only
- Saturated felt
- Parking Lot Coatings
- Sports Track
- Cork
- Adhesives
- Paint
- Mastapave
- Tennis court surfaces
- and other industrial accumulations

All Strippers come with tools and an assortment of blades to get you started.



Electric

Articulating Suspension

Patent #6273513 & Patent pending.

All specifications are approximate

Floor Preparation

The #465VDC Variable Drive Control Self-Propelled Stripper

It goes **FASTER...** and it goes **SLOWER...** than the original self-propelled walk-behind stripper

Less than 1/2 the cost of competitors self-propelled strippers!

When the material you are removing is coming up easy, you can easily speed up the machine and plow right through.

When the material is really stuck hard, you can slow down to let the machine's back-and-forth action work on the material to get it up without jumping over the top of it.

If the machine does jump up on top of the material, you can now immediately back up and take another bite by simply

reversing the machine instead of having to stop, tilt the machine back, and pull the machine back to take another bite.

With these improvements the #465VDC can tackle the hard-to-remove projects that are beyond the capabilities of self-propelled strippers that don't have quick reverse and variable speed controls.

Check these features...

1 YEAR
Limited Warranty



To back-up, simply squeeze the handle lever. The blade action stops and the 465VDC reverses direction.



Twist the handle for infinitely variable speed control between 0 to 27 ft/min.



An emergency stop switch instantly cuts power to the motors and drive control.

Auxillary weight for hard to remove floor coverings.

Weight retention for the hood and base weight is now done with an adjustable lever that is quick, strong and precise.



The front weight is 50% heavier to add more dig-in power and better traction. The weight is secured by a "T" Bolt fastener. This new fastener system totally eliminates weight vibration.

Blade clamping has been improved on the #465VDC, with the addition of a doubling plate that strengthens the blade clamp power with only two fasteners to tighten.



All and all the new #465VDC has all the control you could ask for at a price that is still a mere fraction of competitive self-propelled machines.

Once again, Taylor Tools has raised the bar for floor removal at affordable prices.



See the 465 VDC in action at taylortools.com/videos.html

All specifications are approximate

#464R with Quick Reverse Control

The #464 Self-Propelled Stripper, already the best stripper on the market, is now the #464R and it's now even better!

The #464R now has a quick reverse control lever to be used at the end of a cut or to reposition the machine. Built around the trouble-free, quiet Model 462 heavy duty stripper, this incredibly powerful machine can quickly and efficiently tackle the most difficult removal jobs - with little or no strain on the operator.

Powerful!

One motor drives the machine with 185 lbs. of thrust while a second motor provides the blade action. The operator steers the machine with little or no elbow grease required.

Fast!

In field tests, the #464R removed Collins & Aikman Power Bond glue down carpet at the rate of more than 27 lineal feet per minute (6" wide strips).

Versatile!

Removes direct glue down carpet, resilient sheet goods, vinyl tile and other difficult floor accumulations.

Economical!

The #464R Self-Propelled Stripper is far less expensive than other self-propelled strippers.

Efficient!

Gets down to and through the adhesive.

Quiet!

The #464R incorporates the #462 blade action which means a quiet operation.

Durable!

The #462 blade action means little worry about repairs and maintenance.

Reliable!

The #464R Self-Propelled Stripper comes with a one year warranty.



1 YEAR
Limited Warranty



4 removable weights reduce the #464R & 465VDC weight from 300 lbs. to 114 lbs. for easy transportation.

All specifications are approximate

Floor Preparation



3 YEAR
Limited Warranty

Heavy Duty Strippers

#462/#463

Super quiet, incredibly effective and practically maintenance free year after year.

#1 for over 40 years in the rental market!

Featuring a **3 YEAR WARRANTY!**

The rental proven design is longer lasting and quieter than the newer machines that have come on the market. That is why we give a 3 year limited warranty for the entire front-end assembly. The 2200 strokes a minute belt driven action and heavy gauge steel construction reduce wear on the moving parts for lower maintenance costs, fewer replacements, and quieter operation.



Back and Forth
cutting

#463

Same features as the #462 plus an easy-to-remove belt guard and no side shields

Features the new Easy-Clamp Blade Clamping System. Allows blade tightening from the top.



Stripper Accessory Package Contents

464R & 465.VDC Accessory Pack (464R.KIT / 465.VDC.KIT)

- (3) 464.06.00 6x6x.062 Tile Blade, concrete or wood.
- (3) 464.06.SD 6x6x.062 Carpet Blade, concrete or wood.
- (3) 464.07.00 6x7x.062 Tile Blade, concrete or wood.
- (1) 460.33.00 Grease Gun
- (1) Manual 464R or 465.VDC

462 & 463 Accessory Pack (460.39.00.KIT)

- (2) 460.15.00 4x6 Tile Blade (concrete)
- (1) 460.16.00 5x6 Tile Blade (wood)
- (1) 460.16A.00 3x16 Carpet Blade w/Holes
- (1) 460.16S.00 3x16 Carpet Blade w/Slots
- (1) 460.30.00 16" Blade Stiffener
- (1) 460.34.00 3x10 Carpet Blade w/Holes
- (1) 460.34S.00 3x10 Carpet Blade w/Slots
- (1) 460.70S.00 7" Slotted Blade (V.C.T.)
- (1) 460.70S.SD 7" Slotted Side Cutting Blade, Carpet
- (1) 460.33.00 Grease Gun
- (1) Manual

260 & 260P.HL Broncos Accessory Pack (260.90.25)

- (1) 260.90.06 Owners Manual
- Engine Manual (propane model only).
- (1) 260P.90.06 CO2 Detector (propane model only)
- (1) 260.90.01 9/16" allen wrench
- (1) 260.90.04 Combination 3/8" allen wrench and by pass wrench
- (1) 260.90.03 1-1/8" Wrench
- (1) 165.07.SD 3x7x.083 Self-Dicing Blade

260 & 260P.HL Broncos Accessory Pack (260.90.25) (continued)

- (1) 165.10.00 3x10x.083 Bronco Blade
- (3) 166.07.00 4x7x1/8" Heavy Duty Tile Blade
- (2) 166.10.00 4x10x1/8" Heavy Duty Tile Blade
- (1) 167.04.00 4x4x1/8" Tool Steel Blade
- (1) 168.01.00 Ceramic, 1" Straight Blade
- (2) 265.12.SD 3x12x.083 Side Cutting Bronco Blade
- (1) 266.06.SD 4x6x.083 Side Cutting Bronco Blade
- (1) 266.12.00 4x12x.083 Bronco Blade
- (1) 266.12.SD 4x12x.083 Side Cutting Blade

260B Hybrid Bronco Accessory Pack (260B.90.00)

- (1) 260B.90.10 Owners Manual
- (1) 260.90.02 16mm Socket
- (1) 260B.90.03 Universal Joint
- (1) 260B.90.02 Extension Bar
- (1) 260B.90.01 Ratchet Handle
- (1) 260B.70.14 Cord Boom
- (1) 260.90.03 1-1/8" Wrench
- (1) 165.10.00 3x10x.083 Bronco Blade
- (3) 166.07.00 4x7x1/8" Heavy Duty Tile Blade
- (2) 166.10.00 4x10x1/8" Heavy Duty Tile Blade
- (1) 167.04.00 4x4x1/8" Tool Steel Blade
- (1) 168.01.00 Ceramic, 1" Straight Blade
- (2) 265.12.SD 3x12x.083 Side Cutting Bronco Blade
- (1) 266.12.00 4x12x.083 Bronco Blade
- (1) 266.12.SD 4x12x.083 Side Cutting Blade

Samurai High Frequency Stripper

#450

Lightweight but very effective on carpet and vinyl
Handle quickly detaches for hand-held operation in hard-to-reach areas.

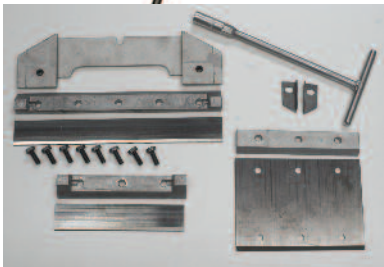

Samurai Accessory Pack #450.90.00 1ea.

- 450.SA.09 Lower Support Bracket 9" 1ea.
- 450.SA.11 Upper Support Bracket 9" 1ea.
- 450.SA.12 Upper Support Bracket 6" 1ea.
- 450.SA.33 Support Bracket 4" 1ea.
- 450.SA.13 Blade, 9" 1ea.
- 450.SA.14 Blade 5.5" 1ea.
- 450.SA.31 Parquet Blade 4" 1ea.
- 450.SA.69 Side Blade Port 1ea.
- 450.SA.70 Side Blade Starboard 1ea.
- 450.SA.34 Bolts, Blade Installation 1ea.
- 450.SA.65 T Handle Wrench 1ea.
- Manual



Hand-held Samurai is the answer for STAIRS



Comes with side-cutting blades for carpet & sheet goods

Stripper Specifications

	464/465	Samurai	462/463	Bronco	Hybrid Bronco
Length*	36"	43	36"	48"	56"
Width	17"	12	17"	29"	29"
Height*	33"	32	32"	44"	53"
Weight w/o Supplemental Weight	114#	N/A	95#	640#	N/A
Wt. of Supplemental Wt.	Nose wt. 43# Hood wt. 44# Base wt. 27#	N/A	40#	600#	N/A
Shipping wt.	320#	35#	140#	1240#	2050#
Motor Specs.	Drive Motor: 1/4 HP 115V 4.6 amps Blade Motor: 3/4 HP 115V 10.8 amps	Motor: 3/4 HP 5 amps 110 volts	Motor: 3/4 HP 115 volts 10.8 amps	7 1/2 HP 220V Single phase 3450 rpm 17 HP Propane 20 lb. Propane tank 8 hr. work time	48 volt DC motor 3600 rpm
Blade Action	2200 strokes per min. back & forth	5800 strokes per min. orbital	2200 strokes per min. back & forth	Fixed Blade	Fixed Blade
Blade Stroke	1/4"	3/16"	1/4"	Fixed Blade	Fixed Blade
Warranty	1 yr.	1 yr.	3 yrs.	1 yr.	1 yr.

* Length and Height dimensions are with handle bar extended
Stripper specifications are approximate

Floor Preparation

DURABLADE with **DYNALLOY**



They're Thicker! They're Stronger! They Last Far Longer!

DURABLES are available in self-dicing(SD) versions to make glue-down carpet removal even faster!

Vinyl Removal

Walk Behind Strippers

Part#	Dimensions	Single Edge	Double Edge	Floor Surface		Holes	Slots
				Wood	Cement		
165.04.00	3 x 4 x .083	x		x	x		
165.04.DE	3 x 4 x .083		x	x	x		
165.06.00	3 x 6 x .083	x		x	x		
165.06.DE	3 x 6 x .083		x	x	x		
165.07.00	3 x 7 x .083	x		x	x		
165.07.DE	3 x 7 x .083		x	x	x		
450.SA.13	9 x 1-1/8 x .040	x		x	x		
450.SA.14	5.4 x 1-1/8 x .040	x		x	x		
450.SA.31	5.5 x 4 x .040		x	x	x	x	
460.15.00	4 x 6 x .062	x		x	x		
460.16.00	5 x 6 x .062	x		x	x		
460.16A.00	3 x 16 x .062	x		x	x		
460.16S.00	3 x 16 x .062	x		x	x		x
460.16S.SD	3 x 16 x .062	x		x	x		x
460.34.00	3 x 10 x .062	x		x	x	x	
460.34S.00	3 x 10 x .062	x		x	x		x
460.70S.00	3 x 7 x .062	x		x	x		x
464.06.00	6 x 6 x .062	x					
464.07.00	6 x 7 x .062	x					

Bronco Ride on Strippers

Propane and Corded Electric

Hybrid Bronco

Part#	Dimensions	Single Edge	Double Edge	Floor Surface		Hybrid Bronco
				Wood	Cement	
165.07.00	3 x 7 x .083	x			x	
165.07.DE	3 x 7 x .083		x		x	
165.10.00	3 x 10 x .083	x			x	
165.10.DE	3 x 10 x .083		x		x	
165.12.00	3 x 12 x .083	x			x	x
165.16.00	3 x 16 x .083	x			x	x
165.16.DE	3 x 16 x .083		x		x	x
166.04.00	4 x 4 x .125	x			x	
166.04.DE	4 x 4 x .125		x		x	
166.06.00	4 x 6 x .125	x			x	x
166.07.00	4 x 7 x .125	x			x	x
166.07.DE	4 x 7 x .125		x		x	x
166.10.00	4 x 10 x .125	x			x	x
166.10.DE	4 x 10 x .125		x		x	x
166.12.00	4 x 12 x .125	x			x	x
166.12.DE	4 x 12 x .125		x		x	x

Caution: blades sharpened on both edges are more dangerous. To safely install or remove blades, use Taylor Tools blades with protective edge. Always wear protective gloves to reduce the risk of serious cuts.

Vinyl Removal

Bronco Ride on Strippers		Propane and Corded Electric				Hybrid Bronco	
Part#	Dimensions	Single Edge	Double Edge	Floor Surface			
				Wood	Cement		
166.16.00	4 x 16 x .125	x			x		x
166.16.DE	4 x 16 x .125		x		x		x
266.04.00	4 x 4 x .083	x			x		
266.04.DE	4 x 4 x .083		x		x		
266.07.00	4 x 7 x .083	x			x		
266.07.DE	4 x 7 x .083		x		x		
266.12.00	4 x 12 x .083	x			x		x
266.16.00	4 x 16 x .083	x			x		x
266.16.DE	4 x 16 x .083		x		x		x

Carpet Removal (Self Dicing Blades)

Walk Behind Strippers		Propane and Corded Electric				Hybrid Bronco	
Part#	Dimensions	Single Edge	Double Edge	Floor Surface		Holes	Slots
				Wood	Cement		
460.34.SD	3 x 10 x .062	x		x	x	x	
460.34S.SD	3 x 10 x .062	x		x	x		x
460.70S.SD	3 x 7 x .062	x		x	x		x
464.06.SD	6 x 6 x .062	x					

Bronco Ride on Strippers		Propane and Corded Electric				Hybrid Bronco	
Part#	Dimensions	Single Edge	Double Edge	Floor Surface			
				Wood	Cement		
165.07.SD	3 x 7 x .083	x			x		
165.10.SD	3 x 10 x .083	x			x		
165.16.SD	3 x 16 x .083	x			x		
165.16.SD.DE	3 x 16 x .083		x		x		
265.12.SD	3 x 12 x .083	x			x		x
265.12.SD.DE	3 x 12 x .083		x		x		x
266.06.SD	4 x 6 x .083	x			x		
266.07.SD	4 x 7 x .083	x			x		
266.09.SD	4 x 9 x .083	x			x		
266.12.SD	4 x 12 x .083	x			x		x
266.12.SD.DE	4 x 12 x .083		x		x		x
266.14.SD	4 x 14 x .083	x			x		x
266.14.SD.DE	4 x 14 x .083		x		x		x

Ceramic/Hardwood Removal

Bronco Ride on Strippers		Propane and Corded Electric				Hybrid Bronco	
Part#	Dimensions	Single Edge	Double Edge	Floor Surface			
				Wood	Cement		
167.04.00	4 x 4 x .125 Tool St.	x			x		
167.04.DE	4 x 4 x .125 Tool St.		x		x		
167.07.00	4 x 7 x .125 Tool St.	x			x		x
167.07.DE	4 x 7 x .125 Tool St.		x		x		x
167.10.00	4 x 10 x .125 Tool St.	x			x		x
167.12.00	4 x 12 x .125 Tool St.	x			x		x

Caution: blades sharpened on both edges are more dangerous. To safely install or remove blades, use Taylor Tools blades with protective edge. Always wear protective gloves to reduce the risk of serious cuts.

Floor Preparation



LockJaws

#200 Patent #4906323

A patented 1 or 2-man carpet clamp that takes a bite out of the biggest jobs. Lockjaws feature stainless steel teeth that really lock onto the carpet and a wide cushion-handled grip that lets a couple of guys really put some muscle into a big tear-up. You can even hook Lockjaws up to a winch.



Double
Lockjaws
#202



Triple
Lockjaws
#203

For even greater holding power when removing carpet with a power winch, purchase ready-made double and/or triple Lockjaws.

Carpet Clamp

#822

A terrific handy and inexpensive device to help you pull up or unroll carpet or sheet goods. Gives you incredible leverage. The harder you pull, the tighter the grip. Every installer's tool box should have one.



#822

Deluxe Carpet Clamp

#824

Works on the same principle as the #822 clamp but the Deluxe model features all cast aluminum construction which makes it a much more durable clamp because there are no welded parts. The all aluminum construction also allows us to make the clamp bigger but at the same weight as the #822 clamp (1.5 lbs.)



#824

Hardened Pins

CARPET TEAROR™



#205

Incorporating the Archimedean principle of first-class leverage, the unique, patent pending #205 CARPET TEAROR turns a large, back-breaking, glue-down tear-up into a fast, easy, one-man operation.



See a video demo at
taylortools.com/videos.html

Stainless steel Sharkteeth provide a no-slip foot grip

For even more power, drop the arm into the lower fulcrum position.

Three Lockjaw clamps give you a firm bite



Floor Preparation



Concrete Removal and Prep Tool

Grind concrete with your standard duty floor buffer (200 rpm max), without fear of damaging your machine. Because the direction of rotation pulls the diamonds across the surface, danger from catching on a crack or expansion joint is eliminated.

Designed with a replaceable latch "blade" concept to easily change used or worn down blades by simply replacing each individual blade.

- DB.CNC.13.100 13" Concrete Tool for 15" Machine (100 Grit)
- DB.CNC.15.100 15" Concrete Tool for 17" Machine (100 Grit)
- DB.CNC.17.100 17" Concrete Tool for 20" Machine (100 Grit)



Mastic Tool

Removes stubborn coatings such as tile glue and mastic, thin set, thin mil epoxies, urethanes and paint. You can use your standard duty floor buffer (200 rpm max), without fear of damaging your machine. Because the direction of rotation pulls the diamonds across the surface, danger from catching on a crack or expansion joint is eliminated.

- DB.MAS.13.25 13" Mastic Tool for 15" Machine (25 Grit)
- DB.MAS.15.25 15" Mastic Tool for 17" Machine (25 Grit)
- DB.MAS.17.25 17" Mastic Tool for 20" Machine (25 Grit)



Hardwood Tool

You can use your standard duty floor buffer (200 rpm max), without fear of damaging your machine. Because the direction of rotation pulls the diamonds across the surface, danger from gapped boards or cut outs such as heater vents catching the tool are eliminated. Diamonds are 50 grit and used primarily to remove hard surface finishes. Subsequent sanding should start at 60 grit or coarser.

- DB.HDW.15.50 15" Hardwood Tool for 17" Machine (50 Grit)



Polymer Tool Polishing System

A revolutionary way to polish with your floor buffer (200 rpm max). Yes, now you can achieve a polished surface without the expense of the large polishing machines. By starting with the Concrete Prep tool, work your way down through all of the grits (wet or dry). You can get a concrete floor to have a beautiful luster. To enhance the luster, use of a concrete densifier is recommended. With diamonds embedded in a polymer matrix, the system provides the cutting and polishing characteristics of diamonds without high pressure, high speed or high cost.

100 Grit

- DB.POL.13.100 13" Polymer Tool for 15" Machine
- DB.POL.15.100 15" Polymer Tool for 17" Machine
- DB.POL.17.100 17" Polymer Tool for 20" Machine

200 Grit

- DB.POL.13.200 13" Polymer Tool for 15" Machine
- DB.POL.15.200 15" Polymer Tool for 17" Machine
- DB.POL.17.200 17" Polymer Tool for 20" Machine

400 Grit

- DB.POL.13.400 13" Polymer Tool for 15" Machine
- DB.POL.15.400 15" Polymer Tool for 17" Machine
- DB.POL.17.400 17" Polymer Tool for 20" Machine

1000 Grit

- DB.POL.13.1000 13" Polymer Tool for 15" Machine
- DB.POL.15.1000 15" Polymer Tool for 17" Machine
- DB.POL.17.1000 17" Polymer Tool for 20" Machine

2000 Grit

- DB.POL.13.2000 13" Polymer Tool for 15" Machine
- DB.POL.15.2000 15" Polymer Tool for 17" Machine
- DB.POL.17.2000 17" Polymer Tool for 20" Machine



#485-17

17" Extreme Machine with vac ready base. w/o pad driver.

Extreme Machine Buffers

Ideal for Grinding, Sanding, Mastic Removal, Concrete Profiling and More!

This rugged buffer shrugs off the abuse of grinding, scarifying and sanding concrete. In fact, the use of EZ Scrape or other grinding attachments WILL NOT VOID THE WARRANTY, unlike other popular buffers.

The Extreme Machine features a triple planetary gear unit with a steel coupling. That's why it has a 1 YEAR WARRANTY on parts and labor even when used with the EZ Scrape and grinding attachments.

- Dual safety switch levers
- 1.5 HP, 110V motor. 175 rpm. Weight 102 lbs.
- Totally enclosed external fan prevents concrete dust and grit from entering the motor windings and wearing the motor out.
- Triple planetary gear box with steel coupling
- 50' power cord



#485-20

20" Extreme Machine w/o pad driver. Vac ready base not available on 20".



#485-17-DC

17" Extreme Machine with vac ready base, Dust Control Conversion Kit (kit includes pad driver, Dust Control Ring, and light). Vacuum not included.

Ready for the VAC 150 or the VAC 100 vacuums.

If dust is an issue, you're covered with the 1200 watt vacuum system.

- Dry vacuum only
- 1200 watt motor, 110 volts AC
- 96" water lift
- 7 gallon tank
- Synfax micron filter, part #485-920

Exclusive!

Floating dust seal maintains seal to the floor.

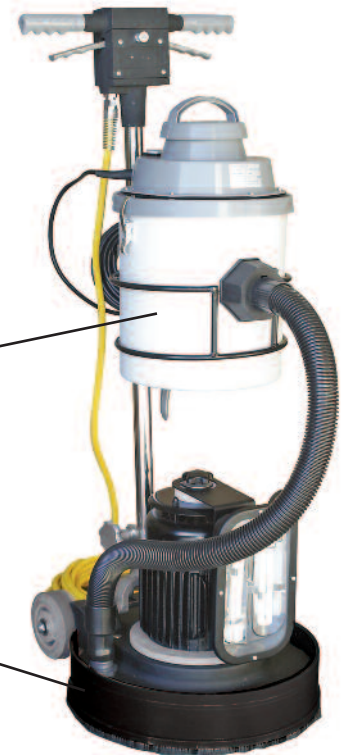

#485-17-VAC-L

17" Extreme Machine with vac ready base, Dust Control Conversion Kit (kit includes pad driver, Dust Control Ring and light). 7 gal. handle mounted vacuum and hose included.

Floor Preparation

Attachments for the Extreme Machine



One additional aluminum clutch plate included



Silicon Abrasive Brushes

Silicon carbide impregnated nylon brushes self-replenish as brush wears to outlast floor pads 100 to one! The best thing for uneven surfaces, wood or concrete. Use 2" smaller than buffer. Comes in 13", 15", & 17" diameters.

- SAB.46 Silica Abrasive Brush 46 Grit, Brown
- SAB.80 Silica Abrasive Brush 80 Grit, Black
- SAB.180 Silica Abrasive Brush 180 Grit, Blue
- SAB.500 Silica Abrasive Brush 500 Grit, Grey

40# Weight Attachment

#485-17-651
Adding this additional weight to your buffer provides extra downward force to let your machine really dig into those hard-to-remove accumulations. Can almost double the production of any attachment.

Floating Dust Control Ring

#485.17.DC.R

EZ Scrape

Removes cutback, multi-purpose adhesives and other hard-to-remove floor residue quickly and easily. No chemicals or disposal issues. The EZ Scrape is a dry removal system. Removes: Paint, Cured Adhesives, Rubber Padding, even Urethane Adhesives.

The EZ Scrape is supplied with a plastic clutch plate for use on standard buffers. An aluminum clutch plate is also provided for use on heavy duty buffers such as the Taylor Tools Extreme Machine #485-17 page 12 if preferred. Use of the aluminum clutch plate on a standard duty buffer with an EZ Scrape may cause damage to the machine.

- #472 - 13" disk for 15" machines
- #471 - 15" disk for 17" machines
- #470 - 17" disk for 19" & 20" machines
- #470-15 - Replacement blades-6 per pack

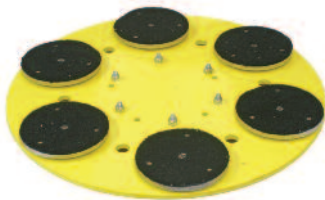

Multi-Head #485-MH

Comes with 6 1/2" velcro pads (#485-1602)

Attachments for Multi-Head



4" EZ Strip Puck
Removes mastic and leveling compounds from concrete.
#485-1615
Attachment: Bolt on



1/4" Titan Puck
For surface profile and adhesive preparation. Removal of rubber padding. #485-1610
Attachment: Bolt on



1/8" Titan Puck
For paint and adhesive removal.
#485-1608
Attachment: Bolt on



4" Scarifier wheels for abrading, removal of glue, paint and concrete sealers and coatings.
#485-1642
Mounting Plate #485-1659



"Red Devil" 4" 30 grit diamond plate. For grinding and concrete removal.
#485-1618
Attachment: Bolt on

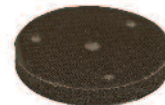

1/2" Velcro Pad
#485-1602



Mounting Plate
5/8" Male #485-1659

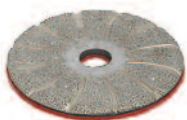

4" 30 grit diamond plate. For sanding and concrete removal.
#485-DIA-30
Attachment: Velcro only



4" Grinding Stone
Silicon carbide stone for grinding concrete to remove surplus material and brush marks, abrading surfaces for adhesive preparation.
#485-1612
Attachment: Bolt on



Carbo Brush.
Scrubbing and cleaning floors.
#485-1636-46
#485-1636-80
#485-1636-180
Attachment: Bolt on



Blue Diamond Cup
4" 30 grit diamond plate. For grinding and concrete removal.
#485-1617
Attachment: Mounting Plate



Wire Brush
For creating stressed wood effect on hardwood floors.
#485-1634
Attachment: Mounting Plate



Sand Paper Drivers

17" #485-17-10
20" #485-20-10



Double-Sided Titanium Shredder

#485-17-1296

This tough attachment is virtually indestructible and gives you a choice of grits -- 12 grit on one side, 30 grit on the other. (Requires a sandpaper driver)

Sand Paper

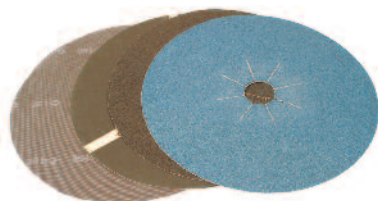

Part No. Grit Backing Pkg. Qty.

16" X 2" DISK 1 Sided, Diamond Back

Zirconium

485-120-024Z	24 Grit	DBZ - CLOTH	10
485-120-030Z	30 Grit	DBZ - CLOTH	10
485-120-036Z	36 Grit	DBZ - CLOTH	10
485-120-040Z	40 Grit	DBZ - CLOTH	10
485-120-050Z	50 Grit	DBZ - CLOTH	10
485-120-060Z	60 Grit	DBZ - CLOTH	10
485-120-080Z	80 Grit	DBZ - CLOTH	10
485-120-100Z	100 Grit	DBZ - CLOTH	10
485-120-120Z	120 Grit	DBZ - CLOTH	10

16" X 2" DISK 2 Sided, Silicon Carbide

485-121-012	12 Grit	SIC - PAPER	10
485-121-016	16 Grit	SIC - PAPER	10
485-121-020	20 Grit	SIC - PAPER	10
485-121-024	24 Grit	SIC - PAPER	10
485-121-030	30 Grit	SIC - PAPER	10
485-121-036	36 Grit	SIC - PAPER	10
485-121-040	40 Grit	SIC - PAPER	10
485-121-050	50 Grit	SIC - PAPER	10
485-121-060	60 Grit	SIC - PAPER	10
485-121-080	80 Grit	SIC - PAPER	10
485-121-100	100 Grit	SIC - PAPER	10
485-121-120	120 Grit	SIC - PAPER	10
485-121-150	150 Grit	SIC - PAPER	10

19" X 2" DISK 1 Sided, Silicon Carbide

485-129-012	12 Grit	SIC - PAPER	10
485-129-016	16 Grit	SIC - PAPER	10
485-129-020	20 Grit	SIC - PAPER	10
485-129-024	24 Grit	SIC - PAPER	10
485-129-030	30 Grit	SIC - PAPER	10
485-129-036	36 Grit	SIC - PAPER	10
485-129-040	40 Grit	SIC - PAPER	10
485-129-050	50 Grit	SIC - PAPER	10
485-129-060	60 Grit	SIC - PAPER	10
485-129-080	80 Grit	SIC - PAPER	10
485-129-100	100 Grit	SIC - PAPER	10
485-129-120	120 Grit	SIC - PAPER	10

Part No. Grit Backing Pkg. Qty.

19" X 2" DISK 2 Sided, Silicon Carbide

485-253-012	12 Grit	SIC - PAPER	10
485-253-016	16 Grit	SIC - PAPER	10
485-253-020	20 Grit	SIC - PAPER	10
485-253-024	24 Grit	SIC - PAPER	10
485-253-030	30 Grit	SIC - PAPER	10
485-253-036	36 Grit	SIC - PAPER	10
485-253-040	40 Grit	SIC - PAPER	10
485-253-050	50 Grit	SIC - PAPER	10
485-253-060	60 Grit	SIC - PAPER	10
485-253-080	80 Grit	SIC - PAPER	10
485-253-100	100 Grit	SIC - PAPER	10
485-253-120	120 Grit	SIC - PAPER	10
485-253-150	150 Grit	SIC - PAPER	10

19" X 2" DISK, 1 Sided, Diamond Back

Zirconium

485-271-024Z	24 Grit	DBZ - CLOTH	10
485-271-036Z	36 Grit	DBZ - CLOTH	10
485-271-040Z	40 Grit	DBZ - CLOTH	10
485-271-050Z	50 Grit	DBZ - CLOTH	10
485-271-060Z	60 Grit	DBZ - CLOTH	10
485-271-080Z	80 Grit	DBZ - CLOTH	10
485-271-100Z	100 Grit	DBZ - CLOTH	10
485-271-120Z	120 Grit	DBZ - CLOTH	10

16" SCREENS

485-125-060	60 Grit	Screen	10
485-125-080	80 Grit	Screen	10
485-125-100	100 Grit	Screen	10
485-125-120	120 Grit	Screen	10
485-125-150	150 Grit	Screen	10
485-125-180	180 Grit	Screen	10
485-125-220	220 Grit	Screen	10

19" SCREENS

485-132-060	60 Grit	Screen	10
485-132-080	80 Grit	Screen	10
485-132-100	100 Grit	Screen	10
485-132-120	120 Grit	Screen	10
485-132-150	150 Grit	Screen	10
485-132-180	180 Grit	Screen	10
485-132-220	220 Grit	Screen	10

Part No. Grit Backing Pkg. Qty.

1/4" Thick FINISHRITE PADS Use W/ Screens or AOS PAPER

485-130-016	16" FINISHRITE PAD	20
485-130-019	19" FINISHRITE PAD	20

4 1/2" Scalloped Quick Stick

485-255-220	240 Grit	SIC - CLOTH	100
485-255-400	400 Grit	SIC - CLOTH	100
485-255-600	600 Grit	SIC - CLOTH	100
485-255-024A	24 Grit	AOP CLOTH	100
485-255-100A	100 Grit	AOP CLOTH	100
485-255-150A	150 Grit	AOP CLOTH	100
485-255-180A	180 Grit	AOP CLOTH	100
485-255-036Z	36 Grit	DBZ - CLOTH	100
485-255-040Z	40 Grit	DBZ - CLOTH	100
485-255-060Z	60 Grit	DBZ - CLOTH	100
485-255-080Z	80 Grit	DBZ - CLOTH	100
485-255-120Z	120 Grit	DBZ - CLOTH	100

4 1/2" Quick Stick SCREENS

485-256-060	60 Grit	SCREENS	100
485-256-080	80 Grit	SCREENS	50
485-256-100	100 Grit	SCREENS	100
485-256-120	120 Grit	SCREENS	100
485-256-150	150 Grit	SCREENS	100
485-256-180	180 Grit	SCREENS	100
485-256-220	220 Grit	SCREENS	100

Silicon Carbide Cloth Backed

PC221-16-16	16" x 16 Grit	10/Box
PC221-16-24	16" x 24 Grit	10/Box
PC221-16-80	16" x 80 Grit	10/Box
PC221-20-24	20" x 24 Grit	10/Box
PC221-7-7/8-24	7-7/8" x 24 Grit	25/Box

SIC = Silicone Carbide - stays sharp
AOP = Aluminum Oxide - lasts long but not as sharp as silicone carbide
DBZ = Diamond Back Zirconium - stays sharp, long lasting, most aggressive.

Urethane Buster! Cured or Uncured



There's nothing else like this terrific, water-soluble solvent cleaner. It quickly and easily dissolves many hard-to-clean organic stains and substances **including urethane adhesive - even cured urethane!**

Biodegradable Oil-Flo 141 is colorless, non-foaming, with a neutral pH, low odor and a high flashpoint (over 141°F). Contains no chlorinated solvents or CFC's. Available in pint, gallon, 5 gallon, & 55 gallon containers.

OIL-FLO 141 dissolves:

- cured urethane adhesive
- mastic adhesive
- asphalt
- coal tar
- cosmetics
- cutback
- graffiti
- grease
- chewing gum
- latex
- oils
- resins
- sealcoat
- tape residue
- waterproofing
- window caulk
- inks
- permanent marker
- tar
- and more!



CLEANUP SOLVENT 22

Cleanup Solvent 22 is a fast drying liquid with a multitude of uses.

- Replaces chlorinated or hazardous solvents.
- Very safe with an NFPA toxicity rating of 0.
- Dries quickly, leaving no residue.
- Non-oily
- Low odor
- Available in pint, quart, gallon, 5 gallon, & 55 gallon containers.

Removes:

- adhesives
- black marks
- fingerprints
- oil and grease

Use on:

- carpets
- wood
- vinyl
- metal
- plastics
- clothing
- vehicles
- painted surfaces
- wallpaper



Contractor-Grade Spud Bar

#403/407

The most powerful, efficient design at an economical price. Twice as heavy (16 lbs.) as standard spud bars and longer length for more power.

Blade holder design prevents build-up. These DURABLADE blades are **50% thicker** than standard blades.

#403-01 3" x .083" Blade

#407-01 7" x .083" Blade

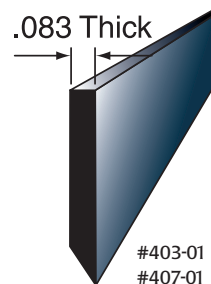

Specifications:

	#403	#407
Blade width:	3"	7"
Weight:	16 lbs.	18 lbs.
Length:	66"	66"

Spud Bar

#303 and #307

Spud Bar with Leverage Handle

#303-03 and #307-07

For those difficult hand stripping jobs, here is a real heavyweight floor scraper with a long life. These all-steel spud bars feature .062" DURABLADES and a comfortable shovel handle.

And for even easier and more effective use, you can order both 3 1/2" and 7" spud bars with a unique, adjustable leverage handle. The optional handle (#308) can also be purchased separately to modify our other spud bars.

Specifications:

	#303	#307	#303-03	#307-07	#308
Blade width:	3 1/2"	7"	3 1/2"	7"	--
Weight:	9 lbs.	11 lbs.	10.25 lbs.	12.25 lbs.	1.25 lbs.
Length:	57 1/2"	57 1/2"	57 1/2"	57 1/2"	--

#303-01 3 1/2" blade

#307-01 7" blade

#308 Leverage handle



Pogo Scraper, Masonry

#309

Pneumatic spud bar great for ceramic and vinyl tile removal. 2500 blows/min. @5 CFM @ 90 psi. Comes w/ 2" solid chisel, blade holder and 6" x 4", 6" x 10" and 6" x 6" blades. Other blades for blade holder available for separate purchase. Hearing and eye protection must be worn.

#309-60-00

#309-50-20

2" Chisel

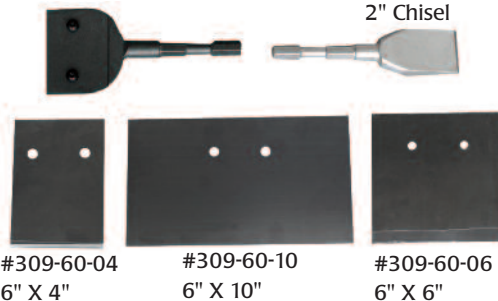

Floor Preparation

For concrete or wood



Dust Collector (dry vacuum only) #VAC-100

Thanks to a uniquely designed, oversized, extended duty filter system, this powerful vacuum can handle concrete dust and other fine dusts from grinding and sanding. Does not use expensive vacuum bags or disposable prefilters.

Powerful (200 cfm) system is virtually maintenance free and the most durable in the industry.

Specifications:

Motor rating: (2) 1200 watt motors, 3.2 HP
Voltage: 110 Volt
Amps: 19 Amps
Noise Level: 76 dba (69 dba w/silencer)
Primary Filtration Efficiency: 99.9% @0.5 microns
2" diameter inlet
Weight: 115 lbs.



Motors are easily removed for service



Quick foot release 9 gal. dust pan



Metal frame supports filter element



Hepa Filter #VAC-100-HEPA

- 99.7% @ .3 microns
- 40 sq. ft. filter area
- Weight: 135 lbs.
- Comes with 20' hose

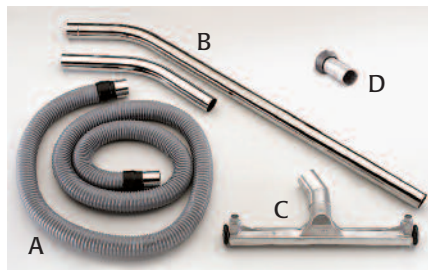

- A. 20' hose standard: VAC-100-100A
B. Optional wand: VAC-100-5003
C. Optional floor tool: VAC-100-5060
D. Hose connector: VAC-100-100B

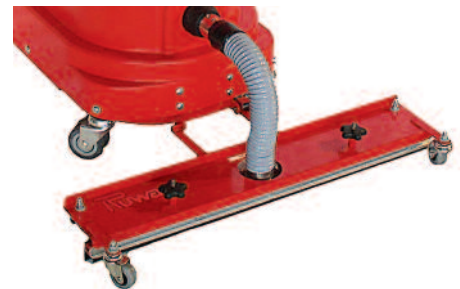

Floor sweep attachment: VAC-100-50

15 Gallon Wet/Dry Vac

#VAC-150

- 5 year tank warranty
- 15 gallon high impact plastic tank
- Water lift 96"
- Durable metal base
- 9" heavy duty non-marking wheels
- Metal wheel base
- 4-piece tool kit
Wand • Vacuum Head • Crevice Tool • Dust Brush
- Water dump hose
- 2 Motors: 1200 watts ea., 1.6 HP/3.5 peak, 325 cfm
- Note: Filter element must be removed to use as a wet vacuum
- 25' x 1 1/2" hose



Replacement Filters

#VAC-150-468



For wood dust

Vac-Pak

#VP-300

- Static dissipating vacuum hose
- Threaded cap eliminates separation of cap and hose.
Reverses for left or right hand use.
- Stainless steel clamps eliminate hard-to-close screw tops
- Vacuum bag deflector keeps particles from tearing the vacuum bag
- Cloth vacuum bag is washable (air dry only) and lasts for years
- Heavy duty paper bag lasts longer and stays stronger under heavy use
- Bag support plate (patent pending) keeps bag from impeding air flow
- Recessed powerhead outlet
- 5-piece tool kit

Weight: 10 lbs.
Height: 23"
Capacity: 10 qts.
Airflow: 150 cfm
Power: 1500 watts
dB: 67
Amps: 11.5
Static lift: 100

Paper filter bags

VP-300-920



Material Handling Equipment



Uni-Lift

#600

The Uni-Lift turns any heavy object into an easy-to-move 4-wheeled cart without balancing or tipping. Strap a pair of Uni-Lifts onto a heavy object, push the lifting lever, and one person (man or woman) can easily move desks, appliances, machinery...up to 800 lbs. Featuring the patented Sta-Tite belt tightener, large 3" casters and rubber bumper guards, the Uni-Lift quickly and efficiently solves your heavy lifting and bulky moving problems. Comes with attached 1 ft. strap w/buckle and 11 ft. strap w/o buckle plus an extra 7 ft. strap w/buckle.

Specifications:

Height: 28"

Width: 22"

Weight: (pair) 45 lbs.

Lifting Capacity: 800 lbs

Not to be used on stairs or steps



The Uni-Lift is used by:

Movers, Floor Covering
Installers, Carpet Cleaners,
Warehousemen, Plant
Operators, Office Managers...

To Move: Furniture, Store
Displays, Air Conditioners,
Machinery, Appliances, Office
Equipment, Crates, etc.



Sta-Tite Belt Tightener

#601

Much smaller and less expensive than ratchet type tighteners, Sta-Tite's unique application of the leverage principle takes a mere flick of the wrist to tighten any 2" strap. Comes with Uni-Lift but also sold separately.



The Mule

#505

The Mule is more compact, lighter and more maneuverable than other carts and it costs less. Yet, it can carry 1,000 lbs., can be hand carried and is easily stored because of its compact size.

Specifications:

Carrying Capacity: 1000 lbs.

Weight: 39 lbs.

Length: 39 1/2"

Height: 18 3/4"

Width: 21"

Tires: 16" pneumatic

Construction: All-steel

Can be shipped by UPS

No-Flat Tire

#500-03-NF

Install on your Carpet Cart or Mule Cart and eliminate flat tires forever! Same Load Rating as standard pneumatic tires.



Carpet Cart

#500

Large 16" pneumatic tires and a heavy gauge tubular steel frame provide a 1,000 lb. capacity for easy carpet and padding handling.

Specifications:

Carrying Capacity: 1000 lbs.

Weight: 55 lbs.

Length: 5'

Height: 22"

Width: 20"

Tires: 16" pneumatic

Construction: All-steel

Can not be shipped by UPS



Moisture Testing



For Moisture Detection, Measurement and Testing in the Flooring Industry

- Detect if there is continuous moisture migration toward the surface
- Test surface and mid-section of concrete slabs
- Reduce chances of excess moisture in wood floors and subfloors
- Identify potential for delamination in synthetic floors

TotalCheck 3 in 1 Meter

#DI-2000

Offers scan and pin moisture modes as well as a thermo-hygrometer that measures ambient temperature and relative humidity (RH) and calculates dew point and specific humidity (GPP). Relative humidity is a crucial factor to consider when installing a floor over a concrete subfloor. The RH sensor of TotalCheck is removable and conforms to the ASTM F-2170 standard to determine if concrete floors have dried adequately before installing a floor covering.

Pin Mode:

- 5%-60% MC wood scale
- Corrects for 69 individual wood species from 5%-60%
- Corrects for temp. from 0°-255°F
- 0.1%-6% sheetrock scale
- 0-100 numerical reference scale for non-wood building materials

Scan Mode:

- 0-300 numerical reference scale

Thermo-Hygrometer with RH Sensor

- Measures temp. from -4°-158°F
- Measures RH from 0-100%
- Calculates dew point
- Calculates specific humidity

General Features:

- Connector for external electrodes
- On-screen reading recall of up to 1400 stored readings
- Date and time stamp for each stored reading
- Job groupings
- Infrared linking to PC or laptop
- Application software - generate reports and manage data
- Includes 9V battery, 1-year warranty, carrying case

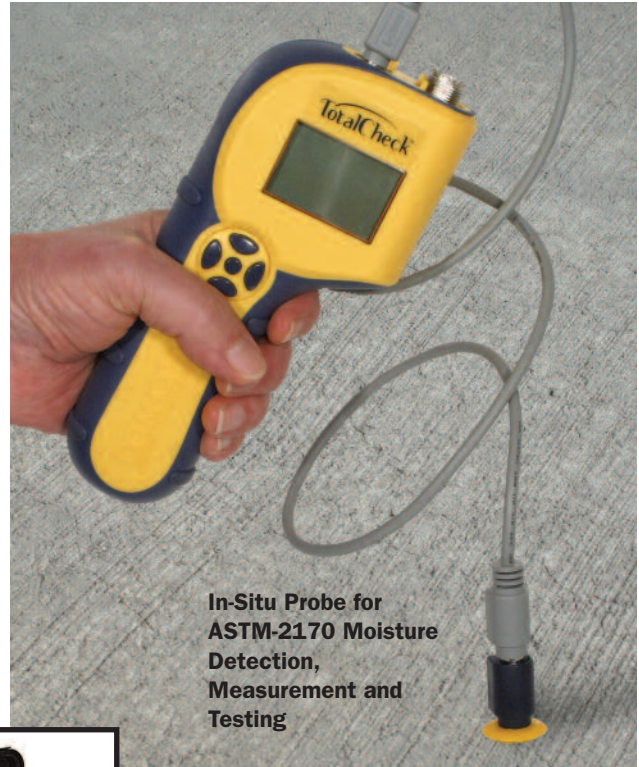

In-Situ Probe for
ASTM-2170 Moisture
Detection,
Measurement and
Testing



Kit Contents

Description	Cat. No.	Qty.
PC Kit	DI.2050	1 ea.
TotalCheck Meter	DI.2000	1 ea.
Sleeves*	DI.2200.20	10 ea.
Humidity Probe** (sensor)	DI.2500.05	1 ea.
2-Pin Electrode	DI.2E	1 ea.
Humidity Probe Cable	DI.2500.RHC	1ea.

*Sleeves are sold 20 per pack

** Probes are sold 5 per pack

PC Kit



- Download stored readings from meter to PC via infrared linking
- Export job data to Excel
- Customize printing options
- View readings and stats in the application program
- Save and print individual or group job readings
- Customize job title
- View temperature in Fahrenheit or Celsius
- Append notes to each job
- Generate graphical histogram

BD-2100

MOISTURE METER

#DI-2100

- Digital readout
- Three scales:
 - **Wood Scale** - 6%-40% moisture range. Use for flooring and building material such as wood studs, floor joists, subfloors
 - **Reference Scale** - reads from 0 to 100 on a relative basis. Use on non-wood materials such as concrete, plaster and insulation.
 - **Gypsum Scale** - 0.2%-50% moisture range. Use on sheetrock
- Averages up to 100 accumulated readings
- Set-point alerts you to when a pre-selected MC is reached
- Connector to attach any available electrode for deep penetration
- One year warranty



J-Lite

MOISTURE METER

#DI-500

- Microcontroller circuit for increased reliability
- Integral contact pins mounted on the meter provide 5/16" penetration
- 12 bright LEDs for reading in direct sunlight or dark areas.
- Moisture Content range from 6%-30%
- Connector for external electrode
- Industry's only 3 year warranty
- Includes 9V battery and carrying case



ACCUSCAN

Radio Frequency Moisture Meter

#DI-1500

- Identify problem areas in hardwood, resilient and tile floors
- Check moisture levels in concrete during drying process
- Easy to read analog readout
- Measures %MC in wood over the range of 6%-40%
- 0-100 reference scale for non-wood building materials
- 3/4" penetration
- Durable electrode pads
- Built-in battery and calibration checks
- 1 year warranty
- Carrying case and 9V battery included



J-2000

Wood Moisture Meter

#DI-J2000HP

- The most versatile wood moisture meter on the market
- Micro controller circuit
- Corrects for 48 individual species and temperature (°F and °C)
- Averages up to 100 accumulated readings
- Measures moisture content over the range of 6% to 40%
- Connector to attach external electrode
- Rugged carrying case
- 1 year warranty



Moisture Testing

Your One-Stop Source for Testing Equipment and Supplies



Calcium Chloride Moisture Test Kits #625

- A Must For Every Installer
- Inexpensive and Easy to Use
- The Most Accurate, Widely Accepted Quantitative Method on the Market Today
- Your Best Insurance Against Liability for Installation Failures Due to Moisture
- Includes Temperature Indicator

First developed by the Rubber Manufacturers Assn. Inc., the Calcium Chloride Moisture Test Kit accurately measures the amount of moisture (in lbs.) coming through the slab over a 1000 sq. ft. area during a 24 hr. period. For many manufacturers of flooring materials, it is the only acceptable method of testing for moisture. Very inexpensive. Price includes test and archival service. Weighs 1 lb.

#625-00-POP

Budget-priced version of the #625 Calcium Chloride Moisture Test Kit, specifically packaged for display sales

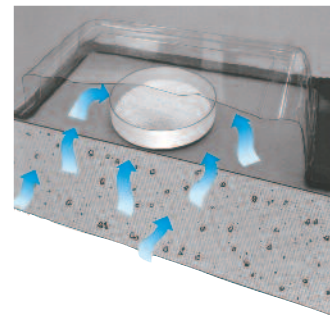

#625-POP-VP

Lowest priced kit. Includes 3 calcium chloride tests and two pH tests.



pH Meter #PH-100

Make quick, precise pH readings of concrete and carpet surfaces. The PH-100 is the only such device that has a surface contact probe.



#625-B

The most economical way to buy CaCl test kits. Each box includes 50 domes and test dishes, 1 ea. instruction sheet and log sheet.



Moisture Test Kit Gram Scale #626

Use to confirm your pre-weight and weigh the Calcium Chloride after exposure. Then do the calculations and send the sample back for free confirmation documentation and archival service of your test.



The new, reusable SuperDome DIY System from Taylor Tools provides substantial savings on your CaCl moisture testing expenses by letting you buy reusable SuperDome protective covers and supplies separately and building the test kits yourself.

Each #625.05.05 SuperDome 5-Pack includes five high-strength SuperDome protective covers which can be used for up to 10 tests - or more.

The 625.10.10 Supply Kit contains enough Calcium Chloride dishes and other materials for 10 tests.

So, for example, you may need only one SuperDome for each supply kit. Now, that's the kind of efficiency that can significantly cut your costs per test!

Pocket Calculator #625-CALC

Do you want to do your own moisture calculations but HATE MATH?

Ask your Taylor Tools distributor for one of our handy 625CALC pocket calculators.

Just line up the test duration with the gain in weight and you'll instantly see your results.

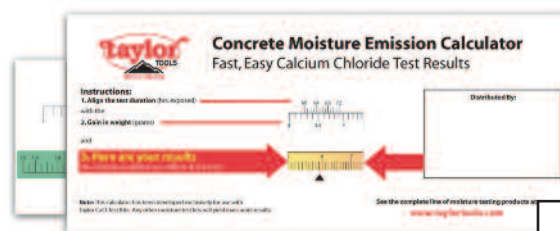

Try our fast, accurate online calculator at taylortools.com/calculator.html

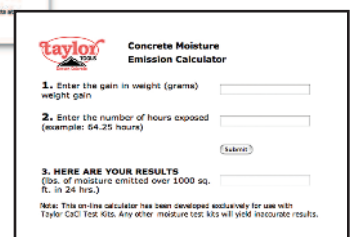

Mini Precision Balance #626-MPB

This highly accurate gram scale is now available from your authorized Taylor Tools distributor for less than \$60.

Small enough to fit in your pocket, the Mini Precision Balance lets you quickly and easily perform your own Calcium Chloride moisture tests without waiting for mailed results.

The #626-MPB is fully compliant with ASTM-F-1869 and features a protective cover and a super-bright backlit LCD display which retracts into the instrument for increased protection and portability.



Pocket-Sized Portability

Retract the display module, snap on the protective cover and you're good to go!



Add "SD" to your order to get the Super Dome



High strength Super Dome transparent cover protects your sensitive Calcium Chloride moisture tests in high-risk areas. Use a single Super Dome for up to 10 tests or more!

Carpet Installation Tools

Power Stretchers Standard Stretcher with Box #748

Taylor stretcher features a 12" head, heavy duty steel teeth and adjustable height. The four inner-outer steel tubing sections are made of a thicker gauge steel and have a larger diameter than competitors for 20% more strength and rigidity.

The #748 Standard includes the 20" Rol-A-Block tail block assembly, one 14" connecting tube, an adjustment neck tube and a durable plastic case.

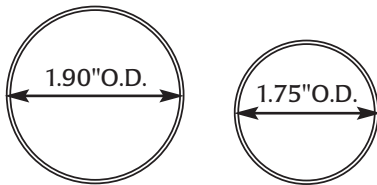

#748 stretcher tubes have a larger diameter for extra strength to reduce bowing on long stretches.



The #748 adapter tubes allow you the flexibility of using competitors tubing with the 748 Stretcher.



Plastic Stretcher Carrying Case #753-60

Durable molded plastic case for easy stretcher transport. Reinforced steel double hinges heavy-duty clasps. Fits all Taylor power stretchers

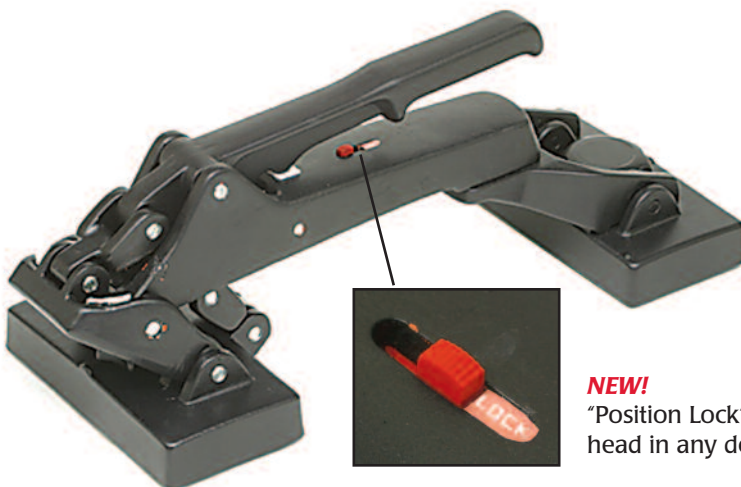

Mini Restretcher with Seam Repair #746

Includes Restretch Blade. Available with Sharkteeth. Just add ST to part no.

NEW!
"Position Lock" locks stretcher head in any desired position.



Deluxe Knee Kicker #825

The #825 Deluxe Knee Kicker features the widest head, the largest bumper pad and one of the longest extensions of any kicker on the market. This combination allows you to move 1/3 more carpet with every kick. The rubber bumper and hand grip also make the #825 Kicker the most comfortable one to use.

But the biggest advantage this kicker has is the unique, hardened stainless steel saw tooth blades which let you really bite into the carpet and at the same time prevent the kicker from clogging up with yarn fibers and scuffing the carpet face like wornout staple nap grips.



What'll it be. . . Hardened steel Sharkteeth blades or flimsy wire staples?

SHARKTEETH

#800-15

The overwhelming success of the stainless steel tooth plate on our #825 Deluxe Knee Kicker led to the development of SHARKTEETH. These hardened stainless steel blades replace wimpy wire staples on any single screw nap grips. 5 times longer lasting, the long pins penetrate deep into pile to positively grab all carpet types.



The #800-15C version of Sharkteeth is made to fit the Crain #600 knee kicker.

Carpet Installation Tools

Stretcher Hook now with Pressure Limiter #737

The popular #737 Taylor Stretcher Hook is now better than ever. An internal spring gives under extreme pressure to reduce the chance of broken prongs. A set screw in the base allows installers to adjust the release pressure.

This innovative, lightweight (1.5 lb.) tool stretches from the floor, not from the wall, so you can eliminate tubes, tailblock assembly and carrying cases. All you need is the #737 Stretcher Hook and stretcher head (adapter tube necessary with Taylor stretcher #748).



Caution: This tool can only be used on carpets that have the manufacturer's approval. This tool will damage the floor surface under the carpet. Installers should not use on hardwood floors.



Kicker Pick/Row Tracker Two Useful Tools In One! #800-16

One end of this unique tool has a series of blades specially designed for fast, easy cleaning of your stretcher and kicker heads including Sharkteeth. The other end traces factory rows on a wide variety of carpet styles.



Adjustable Row Tracker/Kicker Pick II #800-17

Adapt this versatile new version of our popular row tracker for any type of carpet. The tip can be adjusted to give various degrees of row spreading. The other end contains blades for fast, easy cleaning of stretchers and kicker heads. Private label available with quantity purchases. Call for pricing.

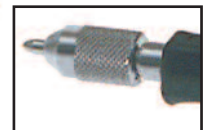

Blunt Setting



Pointed Setting



Multi Purpose Wall Trimmer #715

Make faster, cleaner cuts without marking walls. Use hooked blades for carpet tiles, slotted blades for regular carpet or vinyl sheet goods. Anti-friction boot snaps on to glide smoothly over sheet goods. Adjusts for most material thicknesses, lays flat for clean, precise cutting under toe-kicks.

#333

The distributor doesn't have your staples in stock? No problem. The heavy duty Triple Threat is the only tool on the market that can accommodate a choice of staples. And the Triple Threat's ergonomic handle and jam-resistant design make pad installation a breeze.

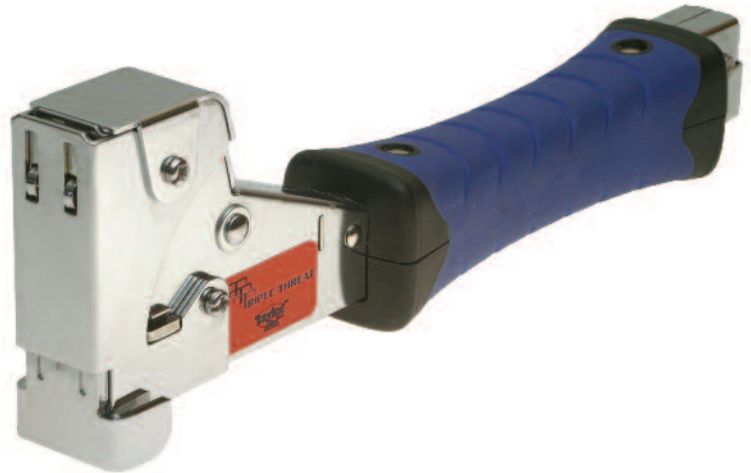

Jam-Resistant Technology!

Chances are you'll never have a jam. But if you do, simply remove the screw from the end of the handle and the Triple Threat swivels open for easy access.

Shoots Your Choice of Staples!

7512: 15/32" crown, 19 gauge
333.7512 Chisel Point
333.7512D Divergent Point



5010: 1/2" crown, 20 gauge
333.5010C Chisel Point
333.5010D Divergent Point

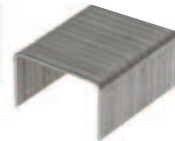

A11: 3/8" crown, 20 gauge
333.A11 Divergent Point
333.A11C Chisel Point

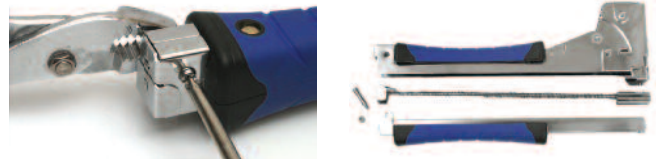

Shock-Absorbent Grip!

"The most comfortable grip of any hammer tacker on the market!"



Carpet Installation Tools

Taylor Seaming Irons

Many of the features on our #893 Tru-Trak Seam Welding Iron have proven so popular that we've incorporated them into our standard irons. Now the best conventional irons on the market are better than ever!



Tail Fin Now Included on all 890 & 896 Irons



#893-05 Nap Spreader allows you to inspect the alignment of the carpet backing as you're making the seam.



Taylor Wide Iron

#896 Patented

- Includes all the same great features as the #890 iron - but it's 6" wide!
- Wafer thin base and shield design reduces profile under carpet (it just seems to disappear)

Taylor Iron

#890 Patented

All Taylor Premium Seaming Irons include a powerful, new 900 watt heating element and a 24' cord.

- An important safety feature - Red light means: "Caution, power on, iron is hot!" Green indicates: "Selected temperature has been reached"
- Temperature control knob on top of handle for easy adjustment.
- Super cool handle features unique setback design for easy seaming under toe kicks. (The new handle is also available as a replacement part.)

Which setting? Now you know!

Now all Taylor premium irons include a valuable handle label that tells you how hot your settings are - so if the carpet manufacturer recommends a certain heat, you'll know exactly which setting to use.

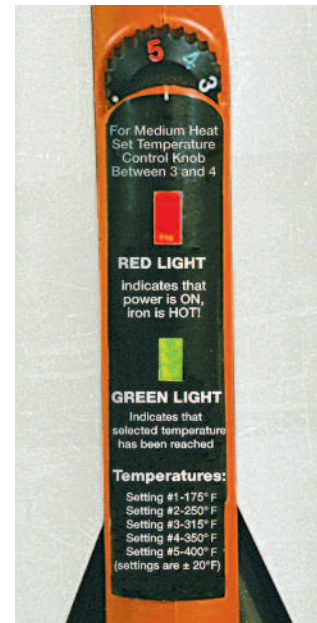

Additional features:

- Patented Teflon Carpet Guard System prevents distortion of Action Bac!
- Exclusive #890 heating area pre-heats carpet backing!
- Super slick, super tough base coating!
- Includes heavy duty iron tray with reinforced iron rests and 24' cord!
- 2 year warranty

Now you can have any of the Taylor Tools Irons with a lighted handle.
 (Just add an "L" to the end of the part #)



New Light On Seaming!

The Nap Light option for all Taylor Tools seaming irons helps prevent seaming errors by providing illumination to the most critical area of the seaming operation.

This combination of floodlight and spotlight built into the handle is powered by the iron's 110V AC current and automatically lights up when the iron is plugged in.

Ideal for closets and other poorly lit work areas, the Nap Light lets you clearly see the smallest details. Check out the Nap Light feature at your local Taylor Tools distributor today!

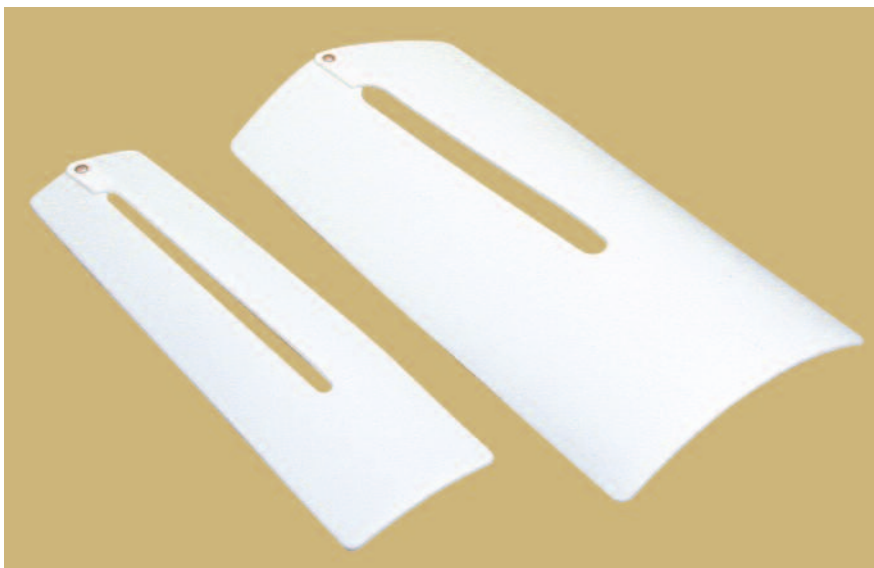

**Universal
 Teflon® Carpet Guards**

#325, #326

The most effective way to **properly** reduce excessive heat reaching the carpet backing. Fits most irons sold today.

If you can't touch the top of your iron without burning your fingers, can it really be safe enough for those heat sensitive carpet backings?

Carpet Installation Tools

1-Step

SEAM SEALING & SEAMING

Much Easier and Faster Than a Glue Gun Tip!

Throw that glue bottle away and meet the future of carpet seaming. The patented 1-Step Seam Sealing and Seaming System from Taylor Tools not only drastically reduces installation time, it results in a better, stronger seam.

The 1-Step Seaming Iron's unique welding head applies a precise amount of hot melt adhesive to the carpet seam edges, locking in the face yarns while simultaneously welding the seam together.

The result? A joint that is actually stronger than the rest of the carpet with a seam that will remain flat even after stretching with virtually no seam peaking.

Instruction in the proper procedure is required for optimum results. Call, write or visit the Taylor Tools website for more information.

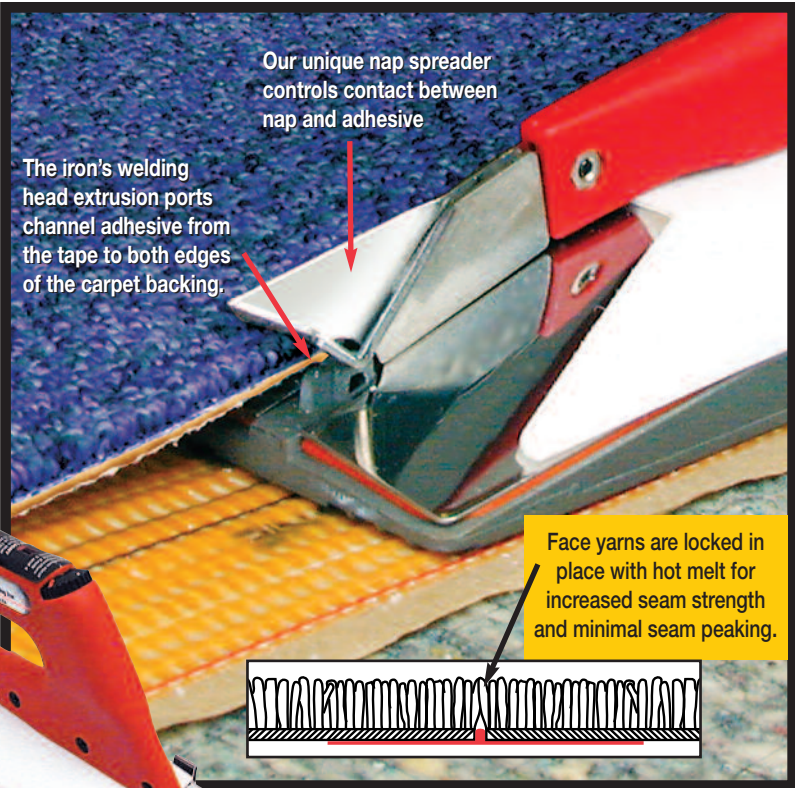

Slashes Installation Time!

Traditional Method



1. Apply a bead of seam sealer to one edge of carpet
2. Apply a bead of seam sealer to the other edge
3. Wait for sealer to dry
4. Seam the carpet

The 1-Step Seam-Weld Method

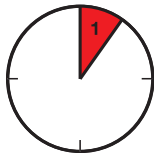

1. Seam-Weld the carpet

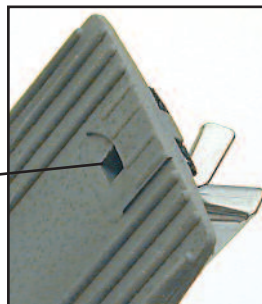

Pickup Port

Taylor #893 Seam Weld Iron

You Can't Make a Stronger Seam!

- Minimizes handling
- Provides a perfect, lay-flat, no-peak seam . . . every time!
- Actually fortifies the seam - now the seam is the strongest part of the carpet
- Ideal for restoration

Major mills prefer 1-Step for making and sealing seams...

"Using the Taylor #893 Seam Weld iron with a trained installer in accordance with the new CRI-105 standard for installation, Shaw Technical Services feels this is an acceptable way to seal carpet seams."

James Mullins
Technical Services Installation Manager
Shaw Industries, Inc.



"Mohawk Technical Services has found the Taylor 893 Seam Weld iron to be an effective way to make and seal seams when used by a trained installer in compliance with CRI-105."

Jack Earwood
Installation Manager
Mohawk Industries, Inc.



See a video demo at
taylortools.com/videos.html

Conventional Seaming Irons

#790 Iron #796 Wide Iron

Now you can get a quality iron at a budget price. These irons include such features as a 900 Watt heavy-duty heating element for fast heat-up, a 5-setting thermostat and a fully grooved base. Both irons come with a heavy-duty iron tray, a 12' power cord (also available with a 24' cord) and a 90 day limited warranty.



#888

#889

Carpet Seam Rollers

Rolling the spiked wheels of the Seam Roller over heat bond seams increases the transfer of the hot melt adhesive to the carpet backing thereby improving the strength of the seam. This action also enhances the appearance of the carpet at the seam. For use on loop pile carpets.

Smooth Seam Rollers

New smooth roller surface is now required for plush carpets. Won't leave tractor marks. Can be used on all carpet styles.

#888 4" Seam Roller

#888S 4" Smooth Seam Roller

#889 6" Seam Roller

#889S 6" Smooth Seam Roller



#889S

#888S

Carpet Installation Tools

Iron Replacement Parts of our Manufacture to Fit Taylor, Roberts* and Orcon* Irons

*Roberts is a registered trademark of Roberts Q.E.P. O'Tool with whom we are not affiliated.

*Orcon is a registered trademark of Orcon Corporation with whom we are not affiliated.



890-15-00
Portage Unit Assembly
 Pkg: 1 ea.
 For Orcon irons, std. & wide.



890-07-00
Wire Harness w/Resistor Light & Ground Wire
 Pkg: 1 set
 For Roberts 182 style iron, standard & wide.



893-02-00
890/893
Wire Harness Fused
 Pkg: 1 ea.
 For Taylor 893, 890, 896



890-06-00
Plain Thermostat Fuse
 Pkg: 5
 For all Taylor & Roberts irons.



890-47-00
Wire Harness w/Resistor Light
 Pkg: 1 ea.
 For Taylor 790, 796 & Orcon irons.



890-46
Wire Harness Fused
 Pkg: 1 ea.
 For 790 & 796



890-05-00
Wire Harness Fused
 Pkg: 1 ea.
 For Roberts 182 style irons, std & wide.

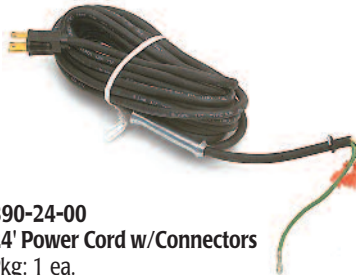

890-24-00
24' Power Cord w/Connectors
 Pkg: 1 ea.
 For Taylor & Orcon irons.



890-12-00
12' Power Cord w/Connectors
 Pkg: 1 ea.
 For Taylor & Orcon irons.



890-22-00
12' Power Cord w/Terminal Block & Cord Spring
 Pkg: 1 ea.
 For Roberts 182 style irons.

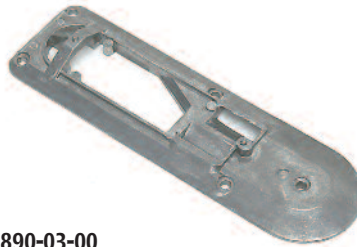

890-03-00
Heat Element Cover
 Pkg: 1 ea.
 For Taylor & Orcon std. width irons.



890-09-00
Heat Shield w/Fasteners
 Pkg: 1 ea.
 For Roberts 182 style, Orcon standard width irons.

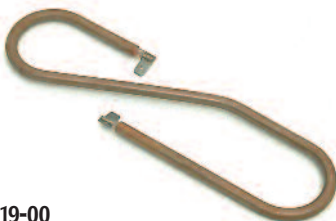

890-19-00
Heat Element: 110 V, 1050 W
 Pkg: 1 ea. For Taylor wide irons, Roberts 286 style, Orcon wide irons. Use on wide irons only.

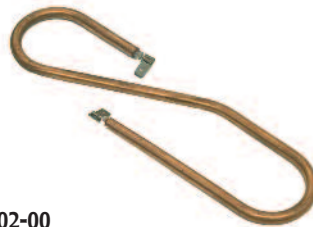

890-02-00
Heat Element 110 V, 900 W.
 Pkg: 1 ea.
 For Taylor 4" irons, Roberts 182 style & Orcon std. width irons.



890-04-00
Thermostat w/Fasteners
 Pkg: 1 ea. For Taylor irons, Roberts 182 style & Orcon irons. Std. & wide irons.

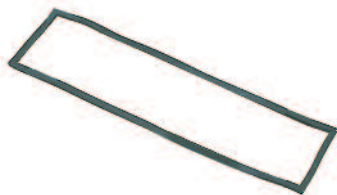

890-08-00
Heat Shield Gasket
 Pkg: 1 set
 For Taylor 790, Orcon irons.

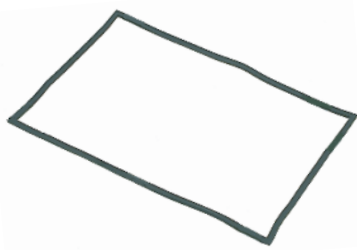

890-18-00
Wide Heat Shield Gasket
 Pkg: 1 set
 For Taylor 796, Roberts 286 & Orcon wide irons.



890-16-00
Handle Gasket
 Pkg: 1 ea. For Taylor 790, 796, Roberts 182 style & Orcon irons, std. & wide.



893-03-00
Heat Shield "O" Ring Gasket
 Pkg: 1 ea.
 For Seam Weld 893 & 890.

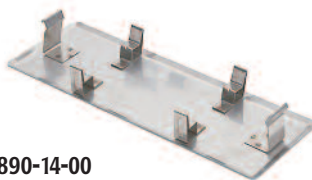

890-14-00
Standard Width Iron Tray
 Pkg: 1 ea.
 For Taylor 890, Roberts & Orcon standard width irons.

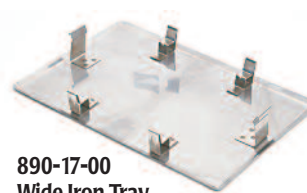

890-17-00
Wide Iron Tray
 Pkg: 1 ea.
 For Taylor 896, Orcon & Roberts wide irons

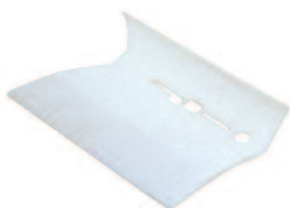

896-03
Wide Carpet Guard
 Pkg: 1 ea.
 For Taylor 896, Roberts 182



890-10-00
Carpet Guard
 Pkg: 1 ea.
 For 890, 893



893-05-00
890/893 Nap Spreader w/Screws & Spring.
 Pkg: 1 set. For Taylor 890, 893 & 896



893-04-00890/893 Handle Set w/Fasteners
 Pkg: 1 set. Specify Red for 893, Orange for 890 & 896.



890-11-00
Universal Handle Set w/Fasteners
 Pkg: 1 set. For Taylor 790, 796, Roberts 182 style & Orcon irons. Std & wide irons.



890-20-00
Universal Fastener Kit
 Pkg: 1 set
 For Roberts 182 style iron, std. & wide.

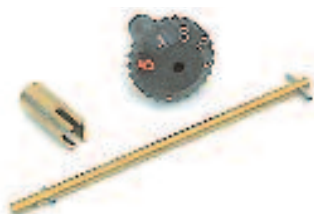

893-06-00
890/893 Temperature Control Assembly
 Pkg: 1 set. For 893, 890, 896.

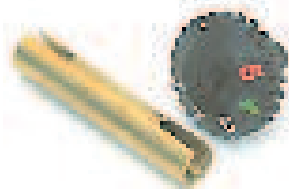

890-13-00
Temperature Control Knob
 Pkg: 1 set (includes 1 knob, 1 extension). For Taylor 790, 796, Roberts 182 Style & Orcon irons. Std. & wide irons.

Carpet Installation Tools

Conventional Trimmer

#716

An improved version of the traditional style carpet trimmer popular with installers. The #716 Trimmer features a non-slip handle grip and a blade stop guide assembly that prevents blade movement during cutting action. The #716 comes with a Delrin guide to prevent marring of base boards and all parts are interchangeable with Roberts #10-616 Trimmer. Comes with a ONE YEAR WARRANTY.



Top Cut Cushion Back Cutter

#998

Adjustable blade cuts any thickness of cushion-back and conventional carpet. Close-cutting on either side with two lockable blades.



Loop Pile Cutter

#999

Cuts virtually any thickness of loop pile. Throat opening automatically adjusts for different carpet backs. Handle attached to support base provides increased leverage, easier guiding and cutting. Two-blade design allows left or right blade operation, better cutting angle, easier blade insertion.



E-Z TUCK

#807

Get rid of your other tucking tools and install carpet 20% faster with the versatile E-Z Tuck.

- Tuck "Z" Bar and metal borders - even heavy berbers!
- Set carpet on tack strip - works great with power stretchers!
- Creases carpet for trimming and tucks carpet smoothly against the wall!
- Goes hand-in-hand with kickers!
- Faster and easier than stair tool for stairs!
- Ideal for glue-down!

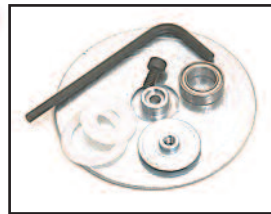

Repair Kit #808-01



Repair Kit #807-01

Deluxe E-Z TUCK

#808

For faster installation and a longer tool life, the Deluxe E-Z Tuck has a permanently lubricated bearing which creates a smoother action and eliminates wear on the wheel.



See a video demo at taylortools.com/videos.html

Stair Tool 3 1/2"

#857

Rugged chisel steel blade drives carpet into crotch on stairs installations and tackless installations. Forged hi-carbon steel, heat treated and tempered for many years of reliable service. Length: 8"

#857C

Soft, no-slip handle grip reduces fatigue and shock. Now available in a rainbow of distinctive colors.



#857



#857C

Carpet Installation Tools



Concrete Nail Driver

#870

Sink concrete nails with a single blow from a standing position with the incredible #870 concrete nail driver.

No misses and no damage to walls resulting from misses because the outer tube (sleeve) guides the inner tube or mallet in the striking sequence - saves fingers and base boards.

The Driver also features a replaceable magnetized tip for locating and holding loose nails and a convenient handle for installation flexibility.

Specifications

All Steel Construction

Weight: 12 lbs.

Length: 47"

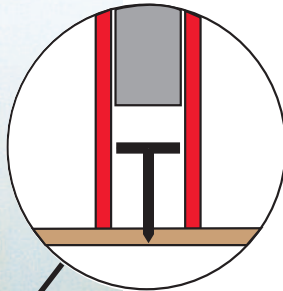

No more stooping or bending over to locate loose nails. Simply use the magnetized head.

replaceable magnetized tip #870-01



BANG-IT!

Door Hinge Pin Remover

#835

- Fast! Easy! Safe!
- Won't Damage Doors or Molding!
- Made in USA!



Door Hinge Pin Remover

#830

Hammer pin up from bottom or pry pin up from top with this hardened nickel-plated steel tool.

carpet cricket

#503
With patented (patent # 6,845,561) "Quick Flip" blade changing technology.

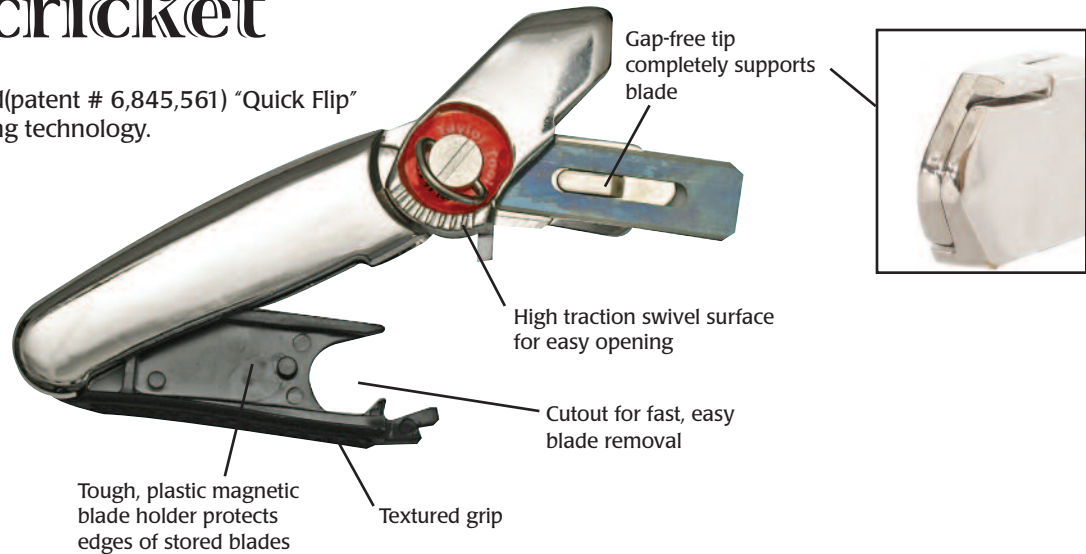

75# Linoleum Roller
#275

100# Linoleum Roller
#280

All Steel rollers - Each section independent of the axle, to automatically compensate for irregularities of any floor. End rollers are recessed and axle bolt is inset to prevent wall scuffing. Round cross bar for easy handling.



Attachable Weight
#250

A 50 lb. attachable weight for more pressure. Fits the #275 and #280 rollers.



Molding Lifter
#818

11" Forged steel. Maximum leverage, with smooth wide ends to eliminate damage to baseboards. Slim notched ends for easy nail and brad pulling.



Aluminum Straight Edge

#904 (36") #906 (75")

Anodized finish protects against damage. Nail hole at one end and 45° mitre at the other. Grooved bottom prevents slipping.

Carpet Installation Tools

Drive Down Bar

#867

For use under toe spaces, and other hard to reach places to drive nails in tackless strip, metal molding, etc. Lifetime guarantee against breakage.

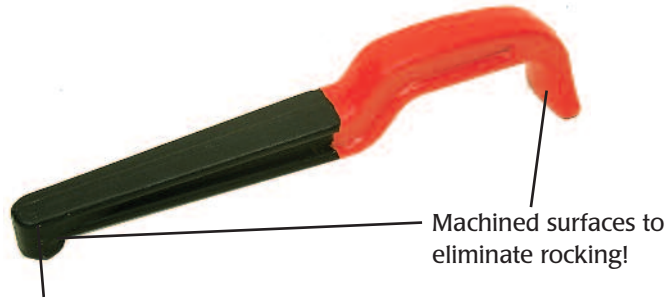

New Super Strong Magnet!

Machined surfaces to eliminate rocking!



#816

#814

#812

#813



#815

Tool Pouches

All our tool pouches are made of top quality grain leather and are constructed to withstand rugged use day in and day out.

#816

Knife pouch

#812

Box with pocket flap.

#813

Flared shape, single pocket pouch with pocket flap. 4 1/2" x 7 1/2" overall size.

#814

Same as #813 without pocket flap.

#815

Five (5) pocket box shape pouch features one large main pocket plus two smaller pockets. Also has two (2) tapered holders. 6 1/2" x 7" x 1 1/2" overall size.

This is the HOT one! 1000° F

Heat Gun

#885

Adjustable air intake regulator provides temperatures from 500°F to 1000°F. Replaceable brushes and Quick Change heating element extends life and eases servicing. Weight: 2 3/4 lbs. including stand. 115V, 15 amp., 27 cu. ft./min air flow.





Carpet Installation Kit

#880

Complete kit of the most frequently used tools for carpet installation. Costs less than purchasing tools individually. Includes 1 each of the following tools:

- #999 Loop Pile Cutter
- #800-17 Adjustable Row Tracker/Kicker Pick
- #812 Box Leather Tool Pouch
- #818 Molding Lifter
- #822 Carpet Clamp
- #825 Deluxe Knee Kicker
- #716 Carpet Trimmer
- #848 Duckbill shear
- #857 Stair Tool
- #888S Seam Roller - Smooth
- #790 Seaming Iron
- #924 24" Tool Box

24" Tool Box

#924

24 $\frac{1}{2}$ " long x 9 $\frac{1}{2}$ " deep x 9 $\frac{1}{2}$ " high.

Heavy duty comfort grip handle. Cap end construction on the cover and shell makes boxes stronger and more watertight. Protective watershed cover, with staked piano hinge. Wide rolled front edges for added strength and rigidity. Heavyweight hardware, heavily plated to prevent rust. Welded-in tray supports. Sure grip handle on 3 compartment tote tray.



Power indicator light lets you know gun is on and hot

"Cool Tip" Glue Gun

#886

60 watts of power. Provides fast, easy seam sealing and carpet repair. Special cool tip on gun protects carpet fibers from heat.



Glue Sticks

#887-01 4" Glue Sticks (30/bag)

#887-10 10" Glue Sticks (12/bag)

Also available in 25 lb. boxes

Special Taylor formula minimizes fiber and backing distortion. Anti-oxidants reduce degradation, **yellowing** and hardening from U.V. exposure. Includes a fluorescent material that reflects "black" light for easy seam inspection. Fits your Taylor, Crain, Orcon or Roberts.



Fits most glue guns

Carpet Repair Tips

#886-05 Micro Repair Tip

#886-06 High Flow Repair Tip

These glue gun tips specially designed for repairing carpet feature a slender, needle-nose design to penetrate the deepest pile. The Micro is for precise repair work while the High Flow is for larger repairs.

Made from a fully hardened copper alloy, the tips heat much faster and stay hot far longer than standard aluminum glue gun tips.

This copper alloy conducts heat 10 times faster than aluminum allowing the tips to be longer with a smaller orifice while not impeding the flow or plugging up. You will be able to make repairs to carpet never before possible with traditional glue guns and tips.

Carpet Installation Tools



18" Broom with Handle #315

Polystyrene bristles with split tips give our brush and broom better sweep action, more durability, better fiber bend recovery and at a far lower cost than horsehair models.

The broom comes with a 5' wooden handle and support hardware. The bristles are 3" long with a brush face of 18" set in a clear lacquer hardwood block.

24" Broom with Handle #314

For those who like a wider sweeping action. Features 3" flagged plastic bristles set in clear lacquer hardwood block. Comes with 5' wooden handle. Weighs 3 lbs.

Counter Brush #310

Brush bristle length is 2 5/8" long with a 9" face set in a clear lacquer hardwood block.

7 1/2" Napping Shears #846

Rug Shears for hooked and candlewick rugs. Solid steel. Nickel plated blades. Double sharp points. Offset handles.



Duckbill Shears #848

Hot forged from special scissor steel, salt bath hardened, nickel electroplated, highly polished. Precision cutting blades that will not gouge while napping.



10" Carpet Shears #845

Hot drop forged. Commercial finished blades. One blade is ground to a knife-edge for faster, cleaner, easier cutting.



12" Carpet Shears #844

Same as #845.



Carpet Binding

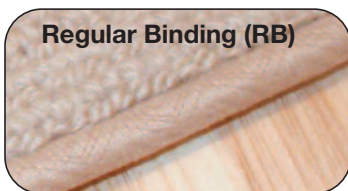

Regular Binding (RB)



Serge Binding (SB)



Rope Binding (RP)

Available in these binding types



INSTANT CARPET BINDING



- Fast, Easy, On-Site Binding!
- No Machinery Required!
- Turn Carpet Scraps & Remnants Into . . .
Throw Rugs
Stair Runners
Carpet Samples
and More!

IB-5000 Starter Kit

Kit Contents:

- 35' of regular binding
- Samples of rope and serge binding
- Glue gun
- Glue sticks
- Color chart/printed instructions
- Instructional DVD



See a video demo at
taylortools.com/videos.html

#WD911



Repair Hardwood Floors, Ceramic & Resilient Floors, Cabinets, Doors, Countertops, Wood Trim and More!



See a video demo at taylortools.com/videos.html

Contents:

DESCRIPTION

Finishing Planer
Hollow Ground Scraper
Hot Knife
Wire Stand, Hot Knife
Felt Pad W/Abrasive
Felt Pad, Smooth
Edge Preparation Pens:
Natural Light
Beech Edge
Cherry Wood
Mahogany
Thermo-Plastic Polymer:
Carrying Case

PART NO.

WD161.500
WD911.6005
WD6015
WD440
WD911.6009
WD911.6008

WD911.5542
WD911.5547
WD911.5544
WD911.5550

WD500

Wood Doctor

TPP103 Cherry Wood
TPP109 Light Walnut
TPP113 Light Mahogany
TPP114 Dark Mahogany
TPP119 Light Pearwood
TPP120 Dark Pearwood
TPP122 Dark Macore
TPP157 Mud Oak
TPP158 Light Beech
TPP160 Medium Alder
TPP162 Alder
TPP205 Medium Spruce
TPP302 Rustic Oak
TPP402 Light Color 402
TPP417 Light Color 417
TPP900 Light Transparent

Ceramic/Vinyl Doctor

TPP103 Cherry Wood
TPP109 Light Walnut
TPP110 Medium Walnut
TPP113 Light Mahogany
TPP143 Dark Oak
TPP158 Light Beech
TPP201 Birch/Maple/Ash
TPP205 Medium Spruce
TPP206 Medium Pine
TPP303 Rustic Oak
TPP350 White
TPP980 Transparent Black
TPP1028 Melon Yellow
TPP3000 Flame Red
TPP5002 Ultramarine Blue
TPP6005 Moss Green

#CD911



Laminate/Vinyl Installation Tools



Laminate Installation Kit

#375

Contains 4 wall spacers, 3 Fast Straps, 3 vacuum cups, 1 power shunting device. All contained in durable steel carrying case.

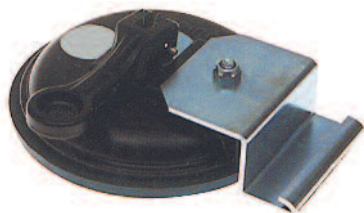

Vacuum Cup

#375-01

Use in combination with Fast Strap and other clamps. No interruption of installation because of suction of the panels from the top.

Fast Strap

#375-33

Cut installation time in half! Uses a rubber cord to create constant/instant tension. No time-consuming ratcheting. . . simply Pull-Place-Release. Includes a built-in tapping block and 25' of glue-resistant strap.

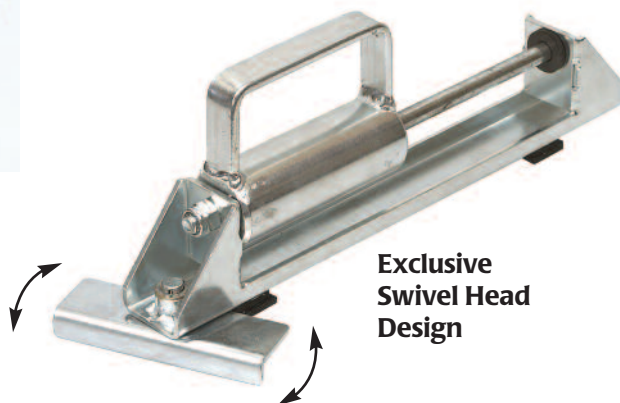

Exclusive Swivel Head Design

Power Shunting Device

#375-03

For fast, efficient installation of parquet, laminate, cork, melamine and hardwood. Combines shunting and hammering. No damage to tongue and groove. Includes new swivel head.

Parquet Spacer

#375-04

Handy wall alignment brace for setting the distance to the wall and adjusting the tension of the floor boards.





Universal Vinyl Tile Cutter

#997 (12")
#997-18 (18")

Easy-to-read measurement in inches and centimeters. Movable or stationary use. Flip-proof handle. Movable tile guide.

Pico Groover

#378

With the Pico Groover there's no need to fumble with a straight edge. Just insert the guide into the seam joint and slide the Groover along the joint while pushing it against the floor.

For maximum versatility and operator comfort, the Pico Groover can be used left or right-handed and can be either pushed or pulled. Both the guide and the blade are fully adjustable to adapt to varying conditions and floor thicknesses.



Before Grooving

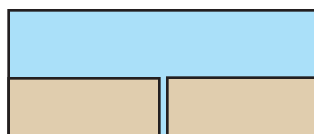

After Grooving

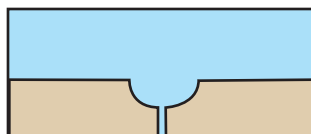

See a video demo at
taylortools.com/videos.html

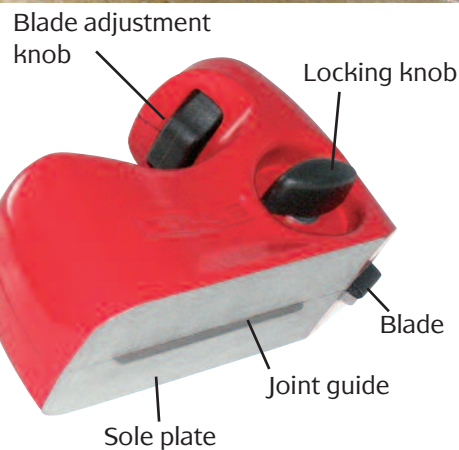

Provinol Seam Cutter

#377

Ideal for:

- Double-cutting two overlapping edges
- Cutting production edges
- Cutting underlying material
- Cutting strips
- Undercutting the edge at 4° angle

Distributed by:



**A Division of Roofing Equipment Inc.
5045 Paris Street, Denver, Colorado 80239
(303) 371-7667 FAX (303) 371-7669**

www.taylortools.com

© Roofing Equipment, Inc.
Denver, Colorado USA 2009. All rights reserved